

General Purpose Enclosed Single Phase NEMA 3R Transformer

- UL/cUL 5085-2 Listed File E47299, CE marked.
- UL 1446 Recognized Class H 180°C Insulation System File E95662
- 60Hz Operation
- Lead Wires: UL3173 XLPE, #14 Gauge 125C Tin Stranded.
- Primary Lead wires Black in color and Secondary Lead wires RED in color.
- Lead Designation (numbering) embedded on Lead wires.
- Knockouts provided on Sides, bottom and back of the Enclosure .
- Hanging slots provided.

Power Rating: 250VA

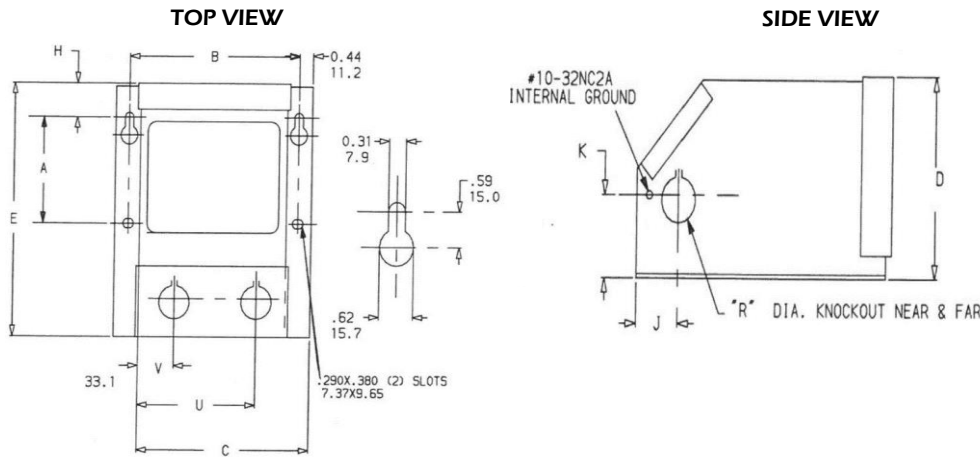

ENCLOSURE DIMENSIONS	
Dims	
A	3.00"
B	5.14"
C	5.30"
D	4.25"
E	7.00"
G	0.29"x0.38"
H	1.20"
J	1.25"
K	2.00"
L	0.99"
M	0.84"
N	2.62"
P	4.50"
R	0.87"
S	0.87"
U	3.16"
V	1.16"

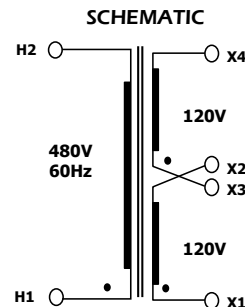
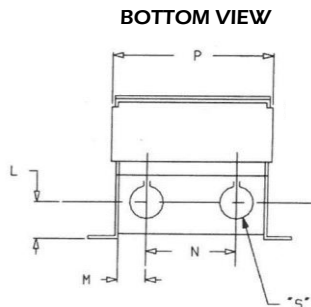

0 Rev	13-Sep-2024 DATE	<p>300 W Factory Road Addison, IL 60101 USA TEL: 630-628-9999 FAX: 630-628-9922</p>
		<p>DESCRIPTION: NEMA 3R General Purpose Enclosed Transformers 480V 60Hz 120/240V 250VA</p> <p>MODEL: GP0250-CM60EN</p>