

# General Purpose Enclosed Single Phase NEMA 3R Transformer

- UL/cUL 5085-2 Listed File E47299, CE marked.
- UL 1446 Recognized Class H 180°C Insulation System File E95662
- 60Hz Operation
- Lead Wires: UL3173 XLPE, #14 Gauge 125C Tin Stranded.
- Primary Lead wires Black in color and Secondary Lead wires RED in color.
- Lead Designation (numbering) embedded on Lead wires.
- Knockouts provided on Sides, bottom and back of the Enclosure .
- Hanging slots provided.

Power Rating: 1000VA

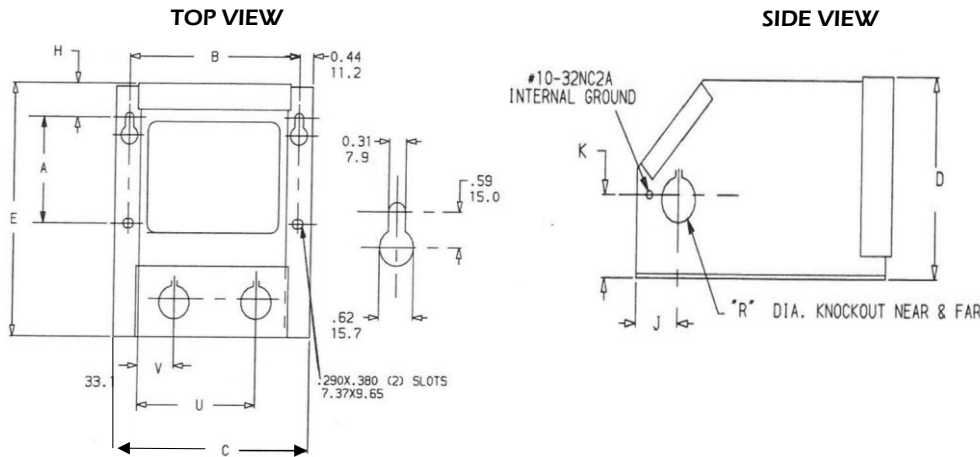

ENCLOSURE DIMENSIONS	
Dims	
A	4.00"
B	6.88"
C	7.88"
D	5.50"
E	9.63"
G	0.29"x0.38"
H	2.06"
J	1.63"
K	2.38"
L	1.25"
M	1.03"
N	4.00"
P	6.27"
R	1.32"
S	1.08"
U	4.25"
V	1.78"

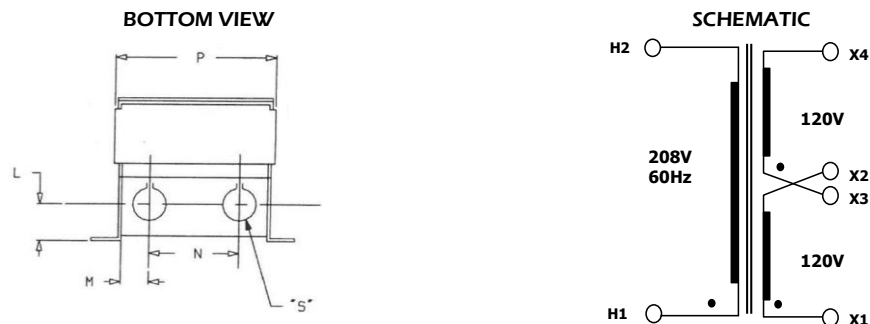

0 Rev	13-Sep-2024 DATE	<p>300 W Factory Road Addison, IL 60101 USA TEL: 630-628-9999 FAX: 630-628-9922</p>
		<p>DESCRIPTION: NEMA 3R General Purpose Enclosed Transformers 208V 60Hz 120/240V 1000VA</p> <p>MODEL: GP1000-V60EN</p>