

General Purpose Enclosed Single Phase NEMA 3R Transformer

- UL/cUL 5085-2 Listed File E47299, CE marked.
- UL 1446 Recognized Class H 180°C Insulation System File E95662
- 50/60Hz Operation
- Lead Wires: UL3173 XLPE, #14 Gauge 125C Tin Stranded.
- Primary Lead wires Black in color and Secondary Lead wires RED in color.
- Lead Designation (numbering) embedded on Lead wires.
- Knockouts provided on Sides, bottom and back of the Enclosure .
- Hanging slots provided.

Power Rating: 1500VA

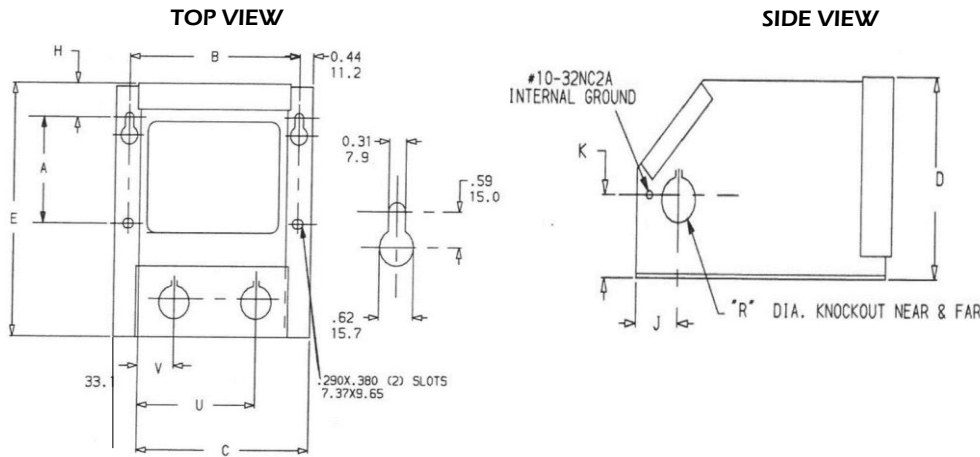

ENCLOSURE DIMENSIONS	
Dims	
A	6.00"
B	8.38"
C	8.50"
D	6.75"
E	11.13"
G	0.29"x0.38"
H	2.05"
J	1.63"
K	2.38"
L	1.72"
M	1.03"
N	5.50"
P	7.77"
R	1.25"
S	1.00"
U	5.00"
V	2.62"

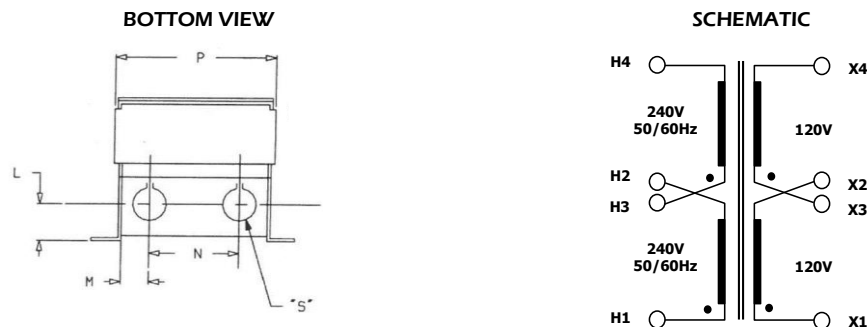

0 Rev	13-Sep-2024 DATE	<p>300 W Factory Road Addison, IL 60101 USA TEL: 630-628-9999 FAX: 630-628-9922</p>
		<p>DESCRIPTION: NEMA 3R General Purpose Enclosed Transformers 240/480V 50/60Hz 120/240V 1500VA</p> <p>MODEL: GP1500-M50EN</p>